

developed by the



# Global Precipitation Measurement Mission

[GPM.NASA.GOV / EDUCATION](http://GPM.NASA.GOV/EDUCATION)

[TWITTER.COM / NASA\\_RAIN](https://TWITTER.COM/NASA_RAIN)

[FACEBOOK.COM / NASA.RAIN](https://FACEBOOK.COM/NASA.RAIN)

## GPM Technology and Instrumentation: LEGO<sup>®</sup> Model Building Guide

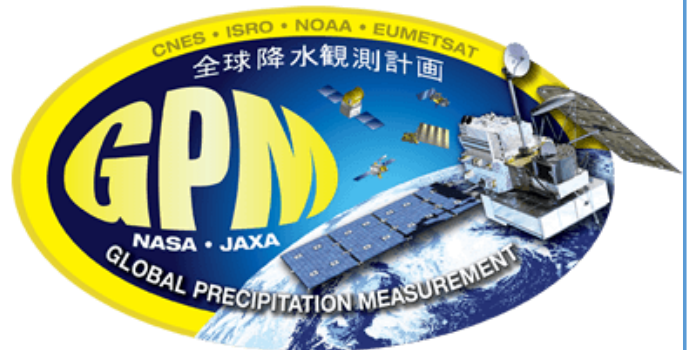
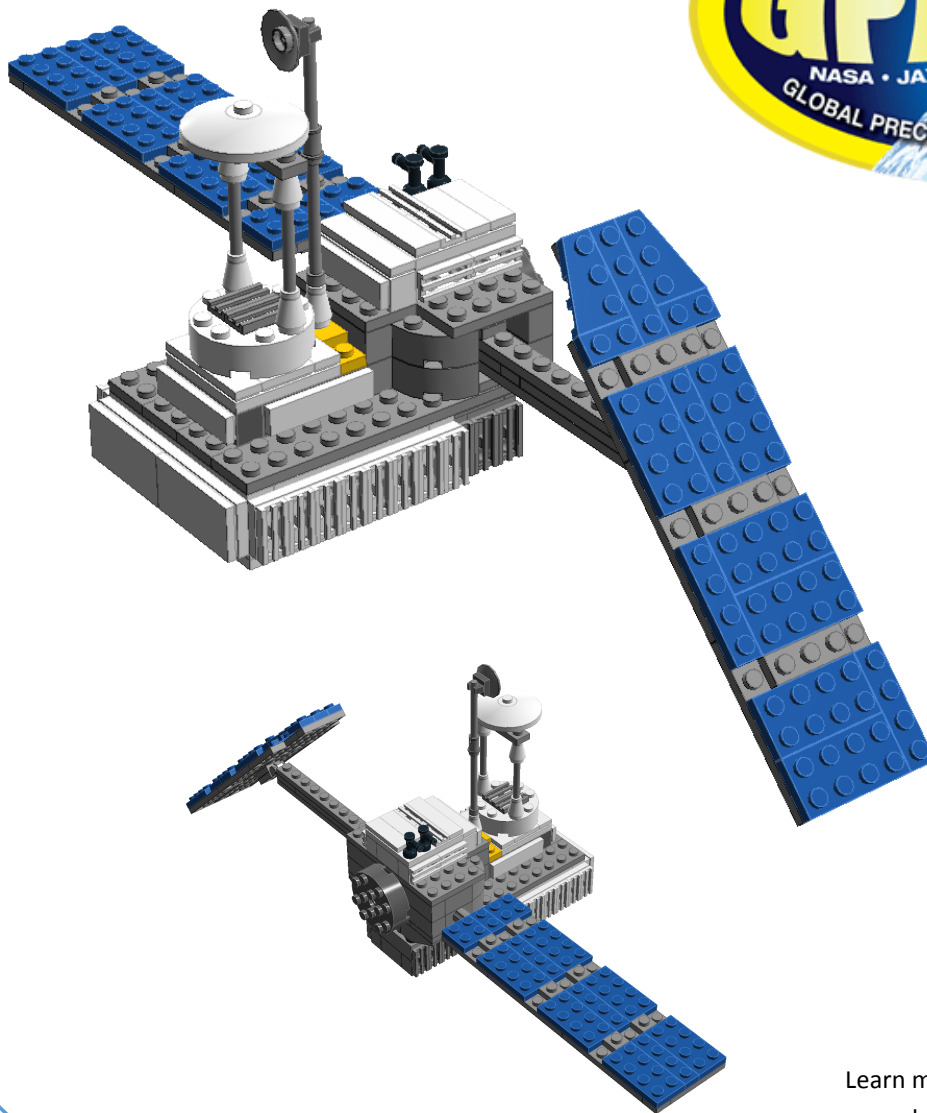

Designed by

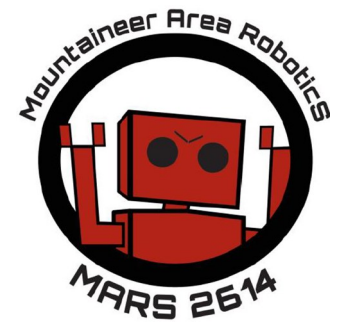

[www.marsfirst.org](http://www.marsfirst.org)



Learn more about the satellite at  
<http://gpm.nasa.gov>

## Part 1: Main Module / Satellite Base

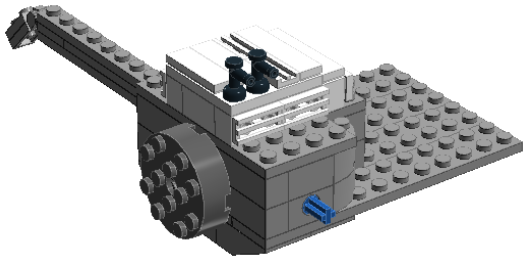

### Fun Fact:

The GPM Core satellite weighs 3850 kg, about the same as a large pickup truck—it is the largest satellite constructed to date at NASA's Goddard Space Flight Center in Greenbelt, Md.

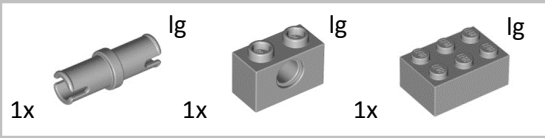

1

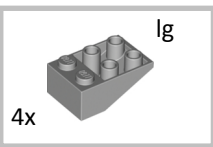
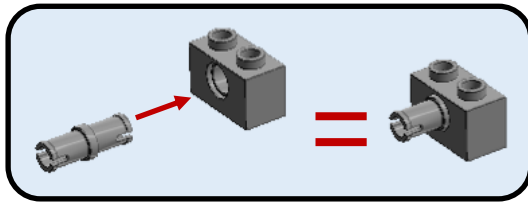

2

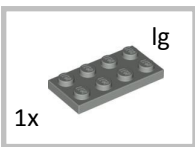

3

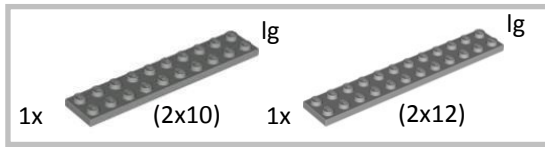

4

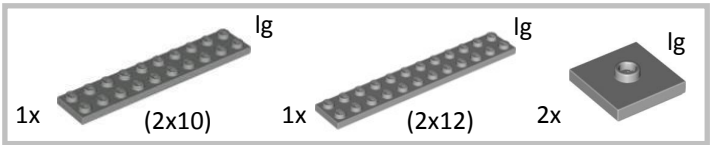
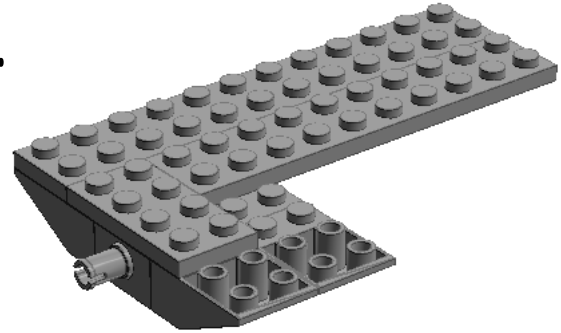

5

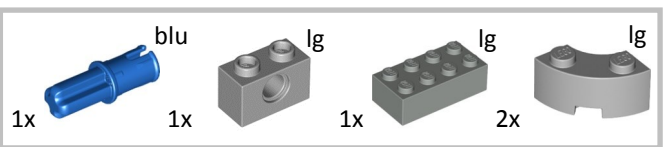
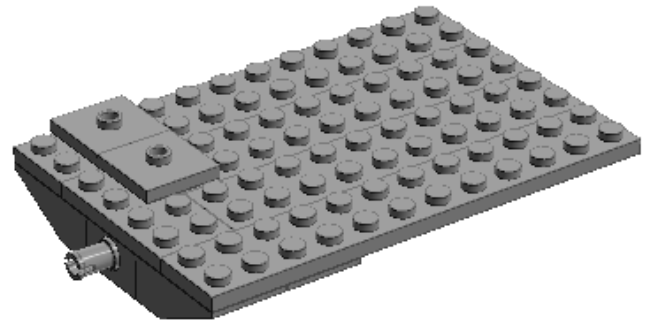

6

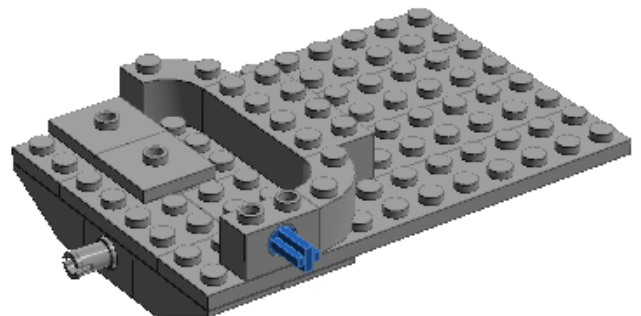
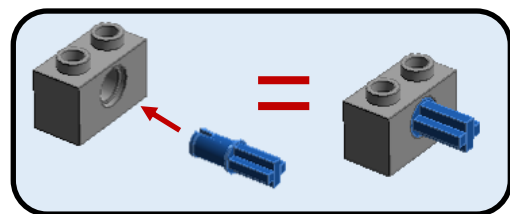

### Key to notations:

1x: indicates quantity used of that piece

(1x2): indicates size of piece—for larger pieces or those without visible studs, based on an equivalent piece with studs

Letters next to piece indicate color, for those printing in black and white:

lg = light gray; dg = dark gray; blu = blue;  
bla = black; w = white; y = yellow

### Fun Fact:

NASA built the GPM Core Observatory in Maryland, and mission partner the Japan Aerospace Exploration Agency launched it into space on February 27, 2014. To get to the launch site on Tanegashima Island, Japan, The Core Observatory traveled by truck, cargo plane, and barge.

Read blog posts and see images and videos about the road to launch  
<http://go.nasa.gov/1iBEJmI>

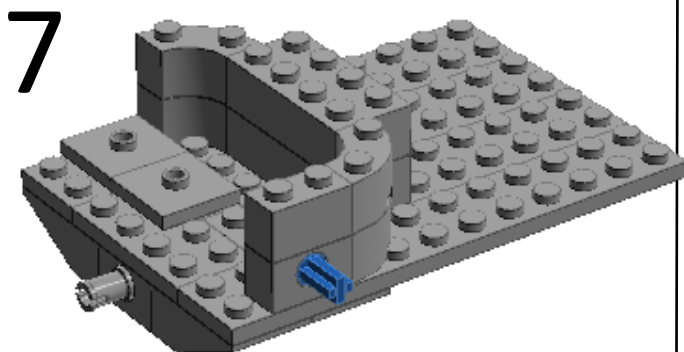
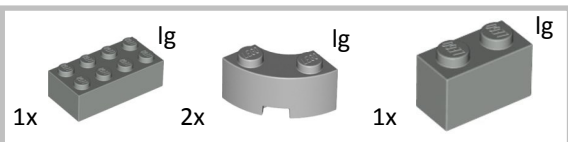

# 8

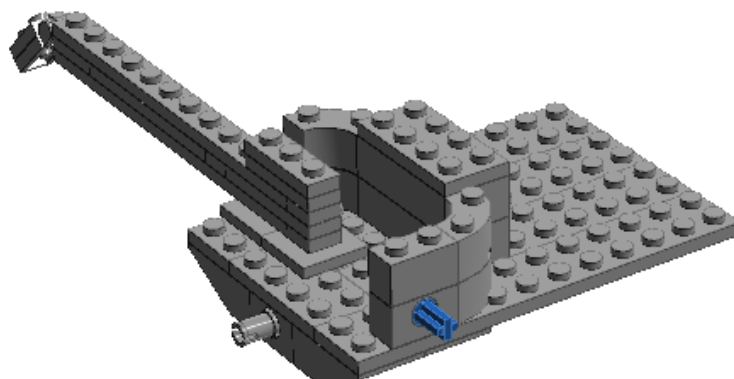
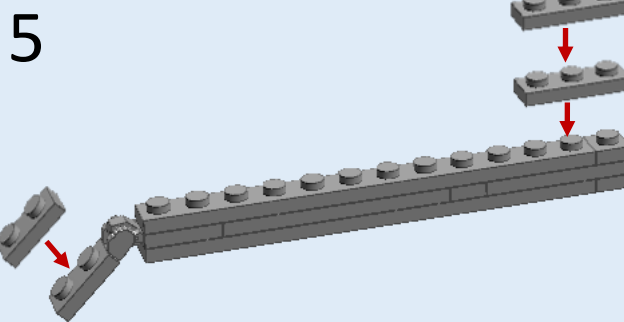
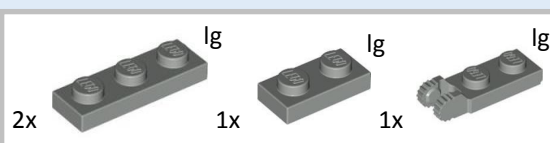
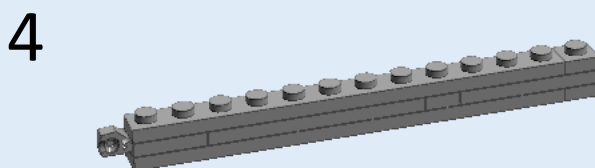
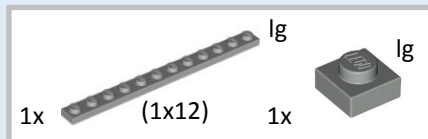
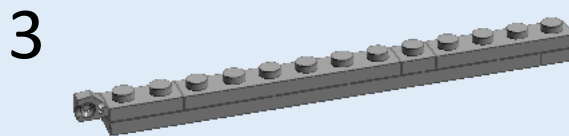
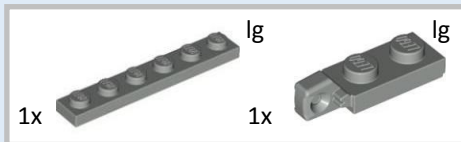
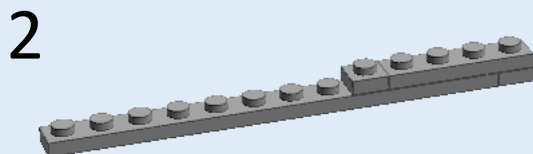
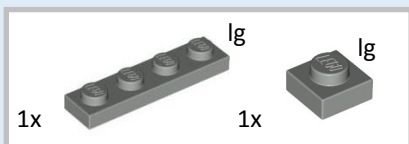
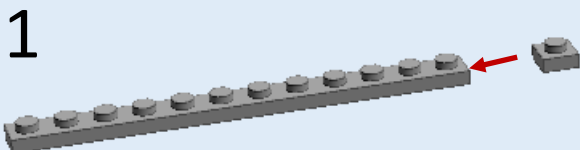
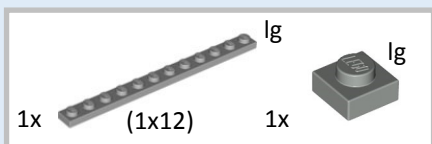

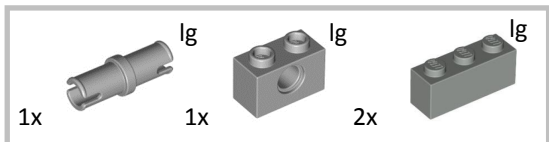

9

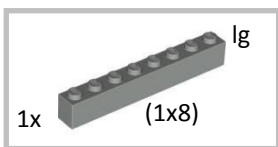
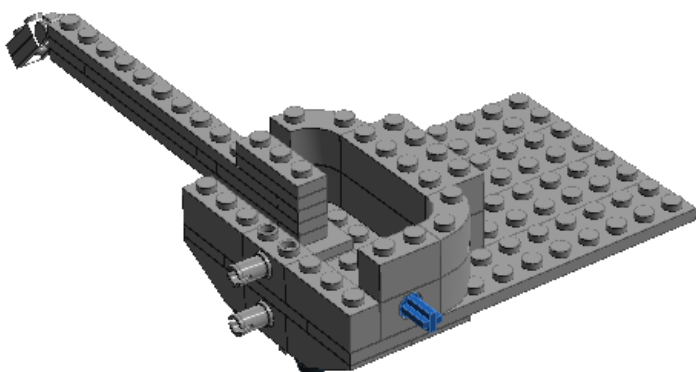
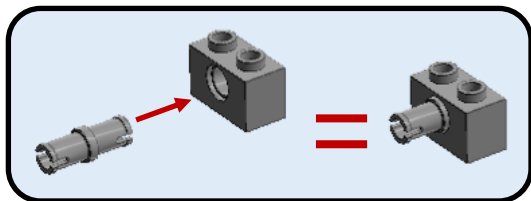

10

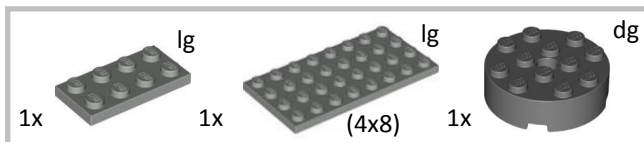
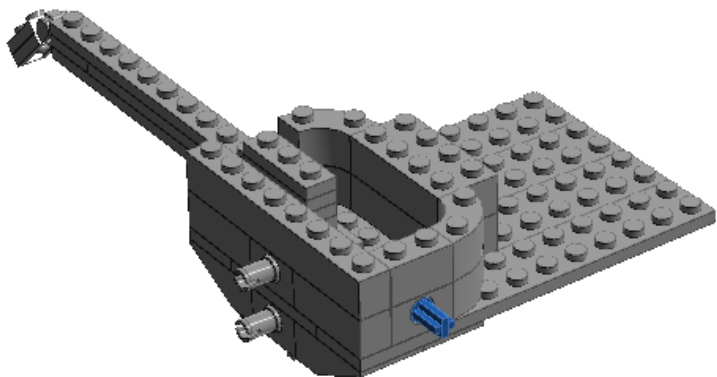

11

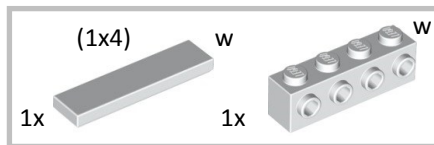
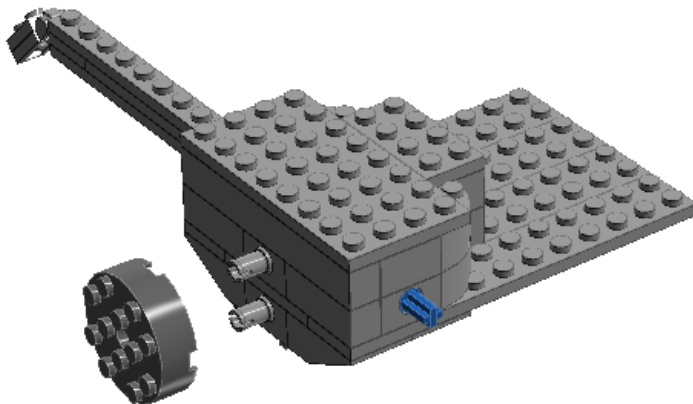

12

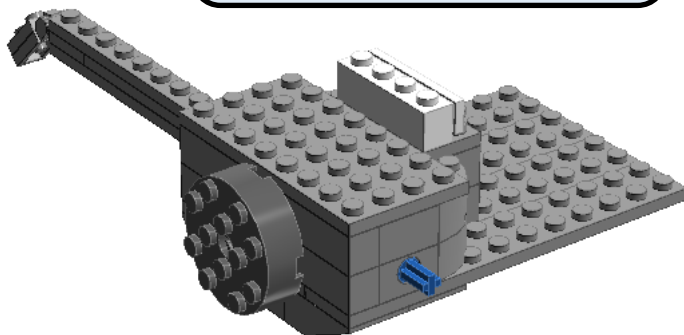
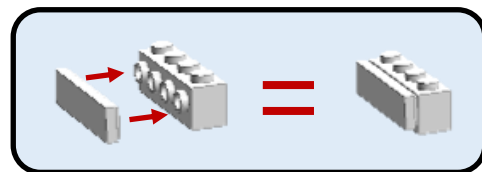

**Fun Fact:**

The GPM mission is the first coordinated international satellite network that will provide near real-time estimates of rain and snow every 3 hours anywhere on the globe. Other satellites in the constellation come from partner agencies of Japan, Europe and India, as well as U.S. agencies such as NOAA.



The GPM satellite constellation  
<http://go.nasa.gov/1dtqF0L>

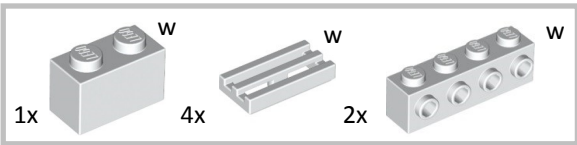

13

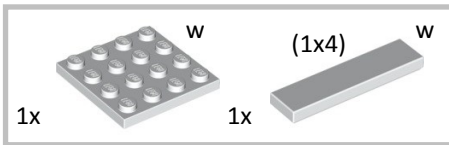
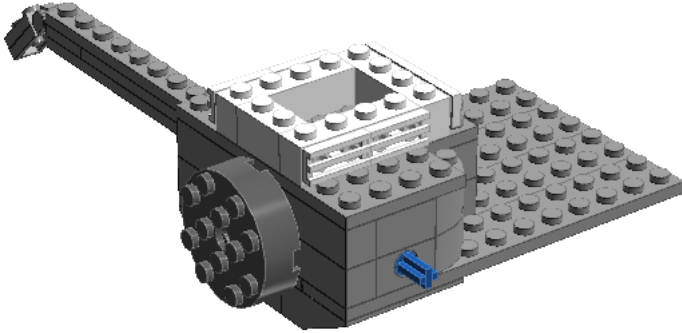
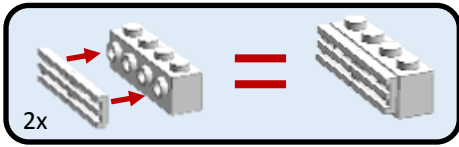

14

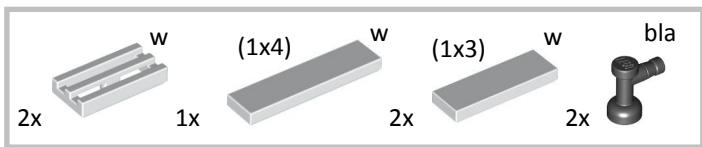
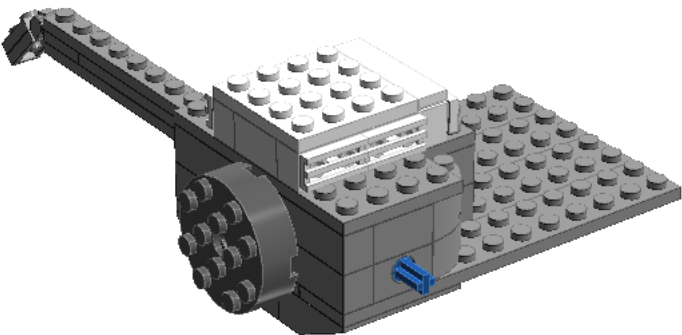

15

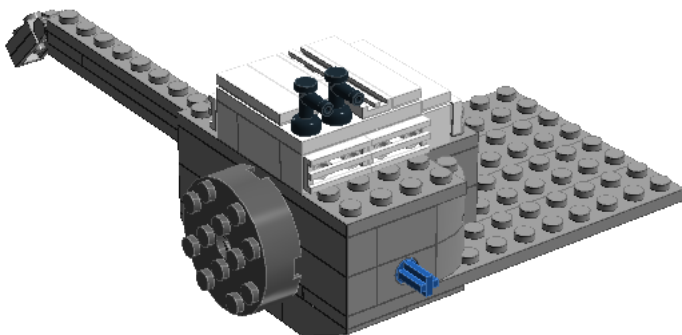

Part 2: GPM  
Microwave Imager and  
High Gain Antenna

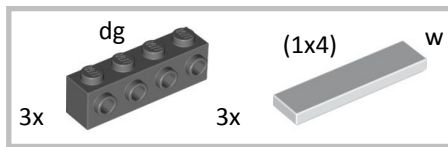
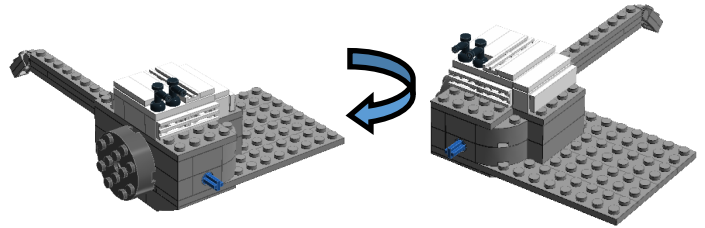

16

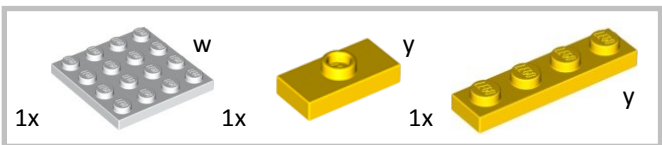
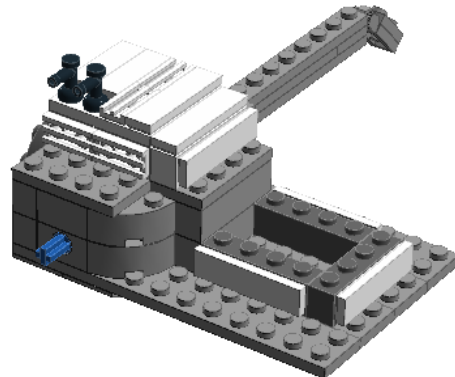
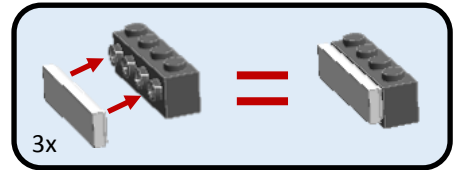

17

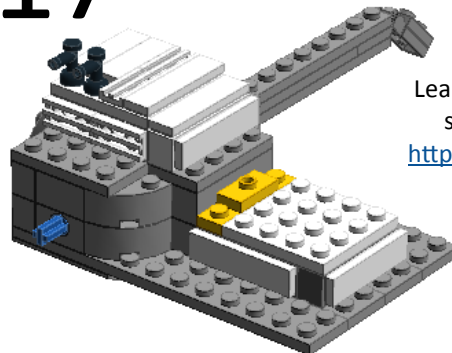

Learn more about the instruments on GPM.

<http://go.nasa.gov/1fdlFjt>

# 18

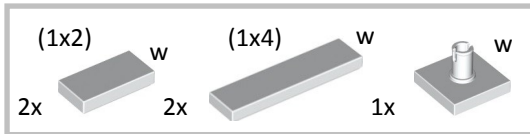
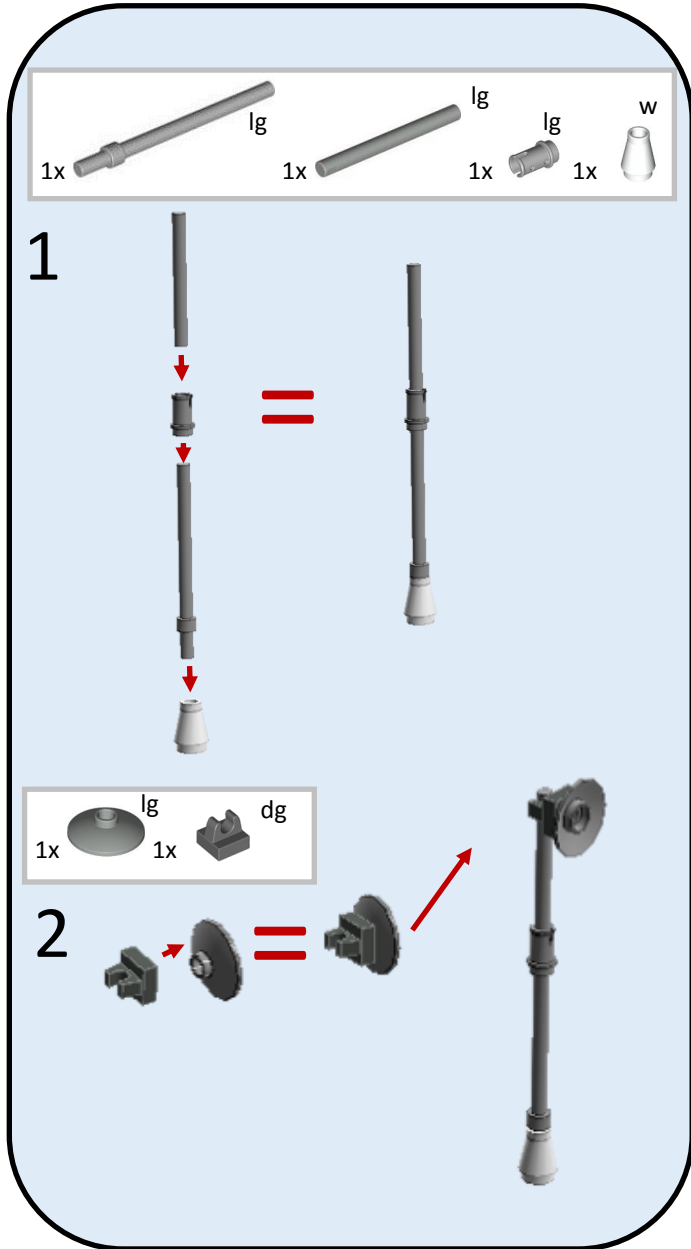

# 19

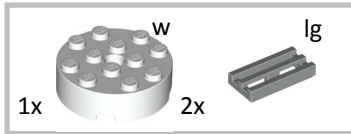
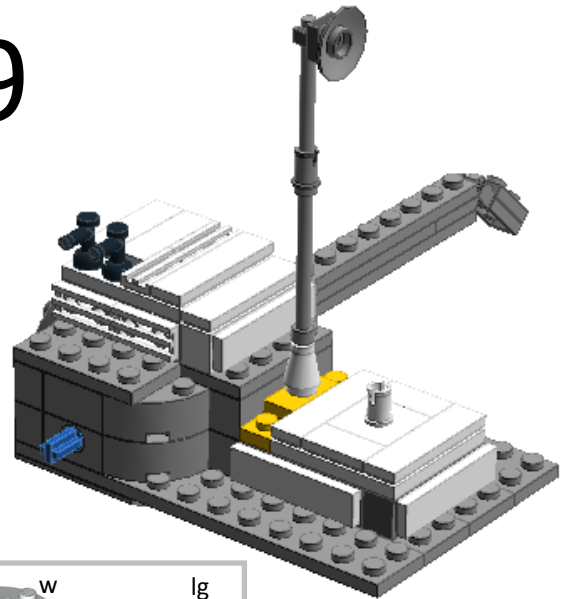

# 20

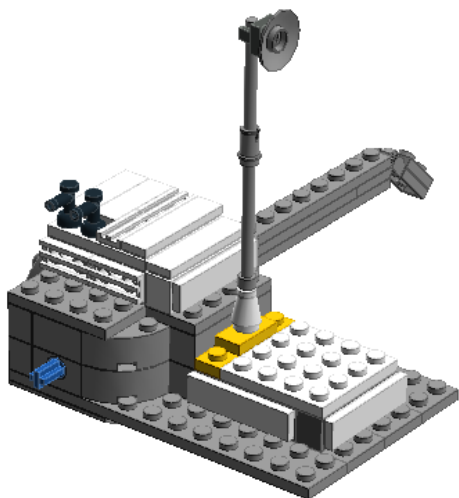
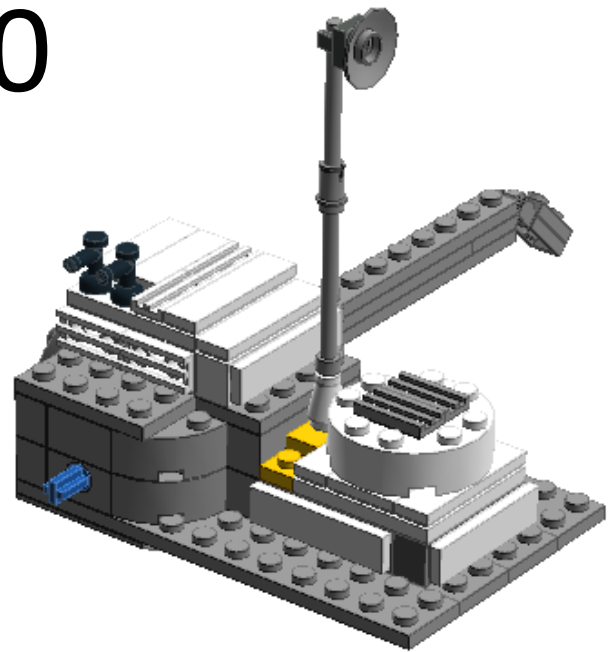

### Fun Fact:

The GPM Microwave Imager is sensitive to 13 channels of microwave energy that allow scientists to distinguish different types of precipitation. It measures heavy and moderate precipitation as well as light rain and snowfall.



See images of some of the first data collected by the satellite.

<http://go.nasa.gov/1iBJ214>

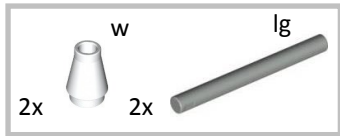

21

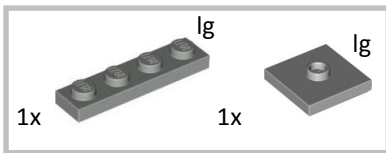
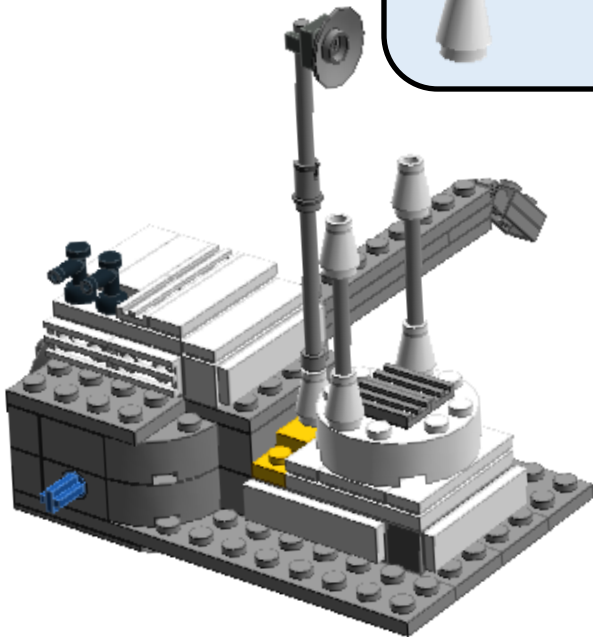
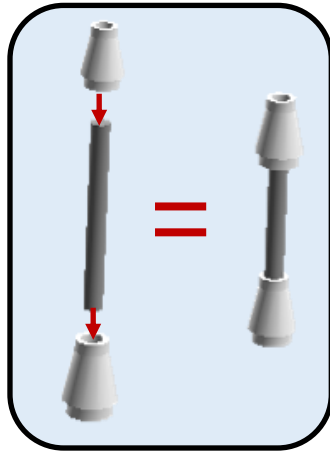

22

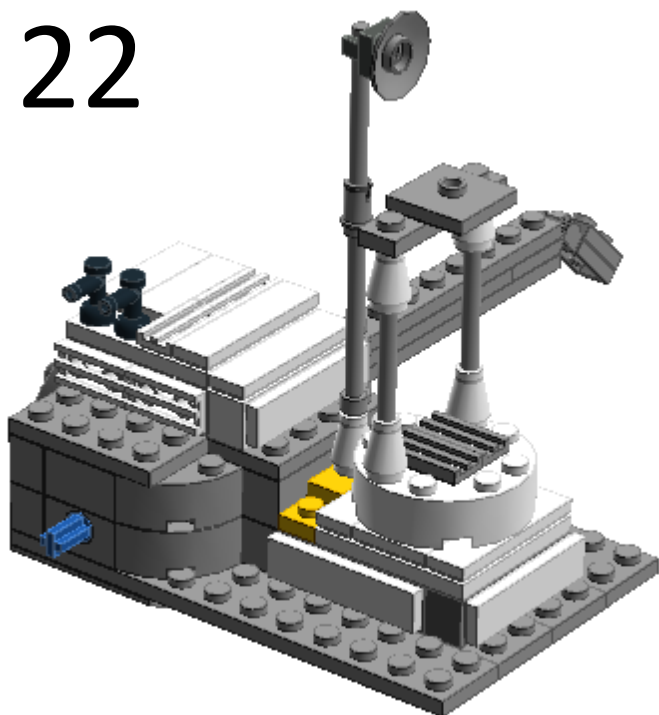

23

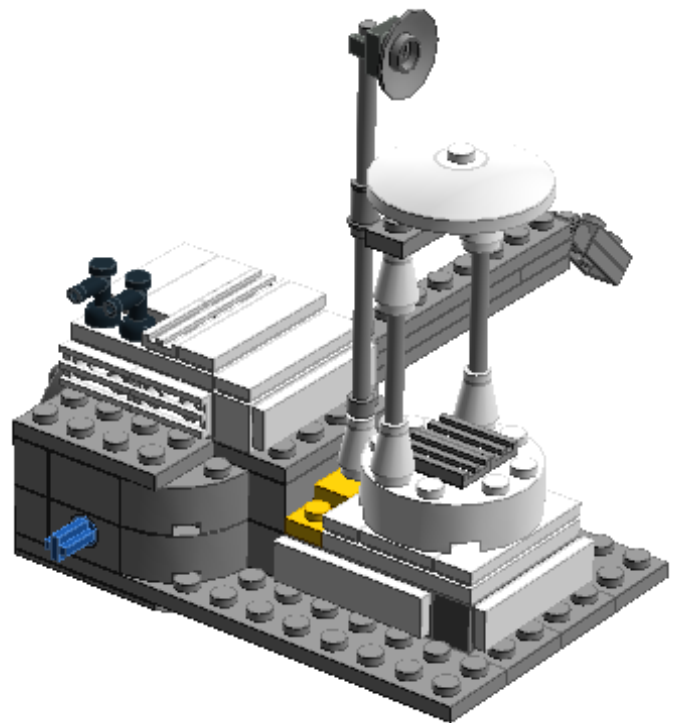
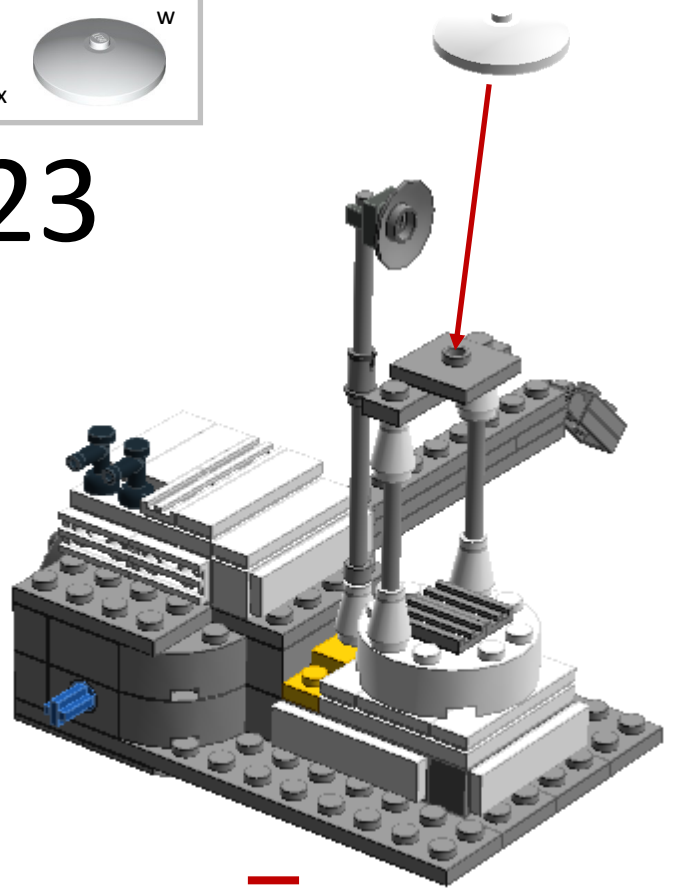

See a video overview of the engineering behind building the GPM Core Observatory.

<http://go.nasa.gov/1iBlurW>



Part 3: Dual  
Precipitation  
Radar

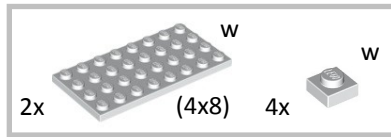
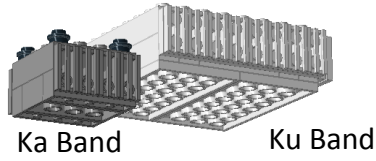

26

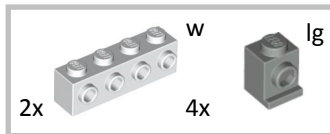
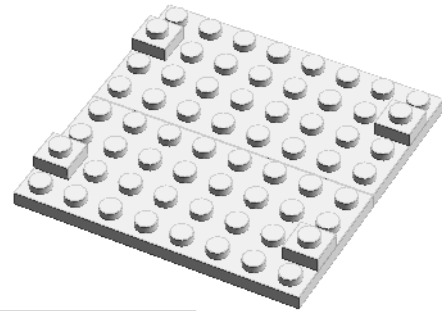

27

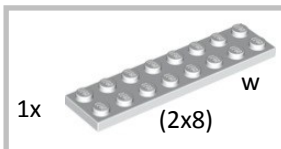
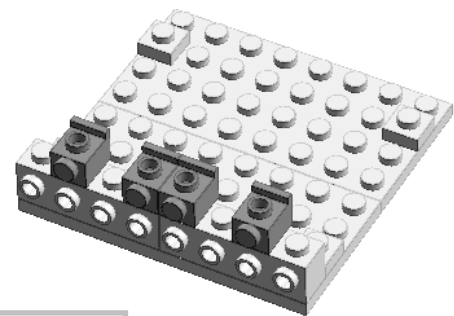

28

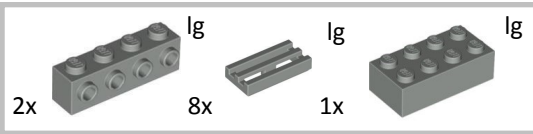
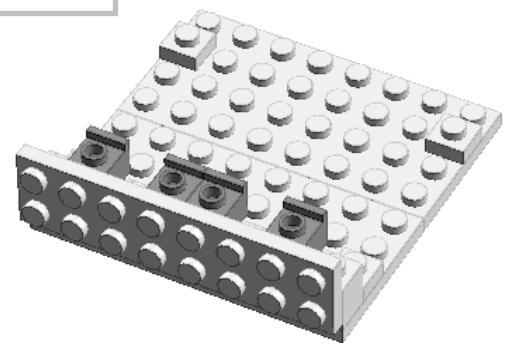

24

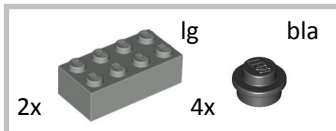
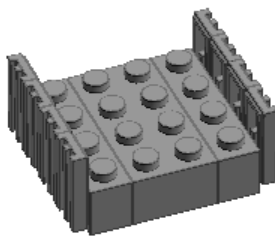
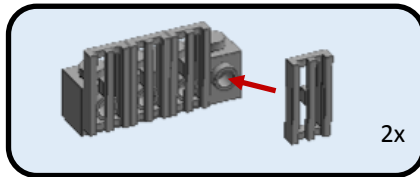

25

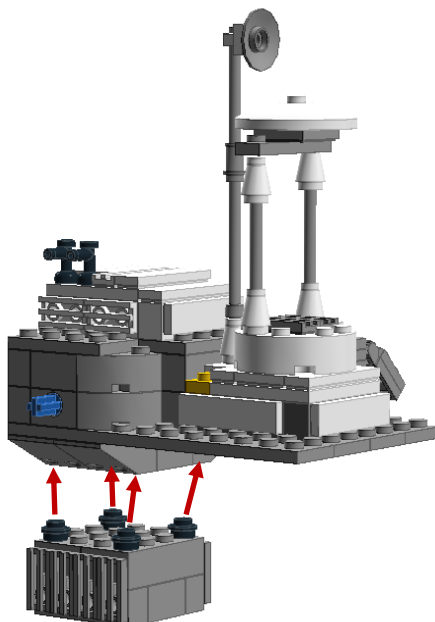
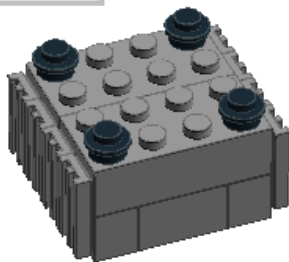

Read more about the DPR  
<http://go.nasa.gov/1iESanI>

And see some of the first data  
images collected from it.  
<http://go.nasa.gov/1r3cpxV>



Fun Fact:

GPM's Dual-frequency Precipitation Radar measures storms and cloud systems in three dimensions. Among other things, the 3-D view allows scientists to see the formation of hurricanes and tropical cyclones forming in the oceans, and to study how these storms change over time.



Fun Fact:

If all the world's rain gauges were gathered together, they would fill two basketball courts. From space, GPM and other satellites provide global coverage to measure rainfall. The GPM Core Observatory will measure precipitation from about the Arctic Circle to the Antarctic Circle.

See an animation showing all the rain gauges in the world being collected in one place.

<http://go.nasa.gov/1iBJtbM>

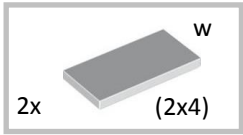

29

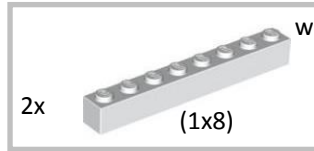
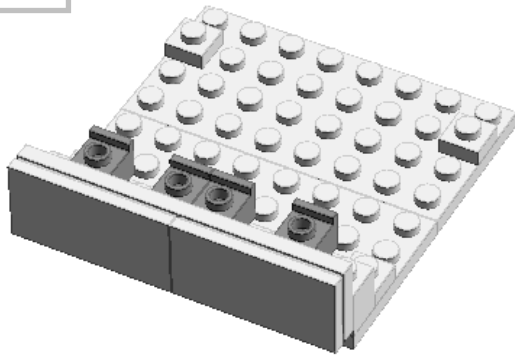

31

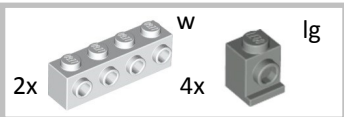
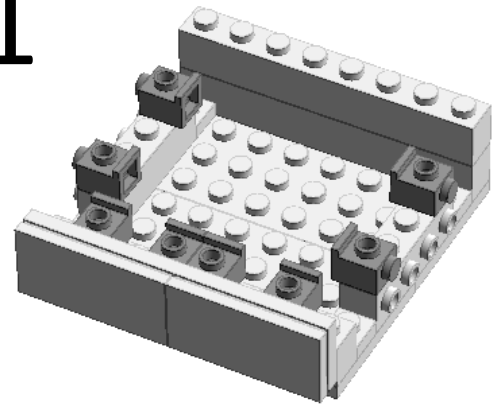

30

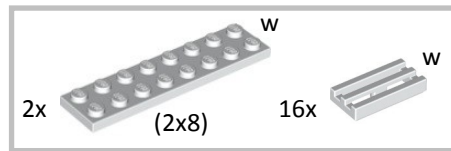
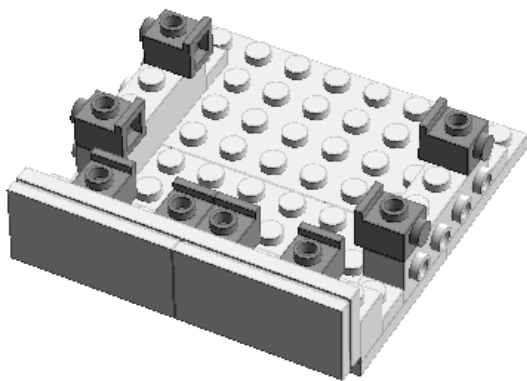
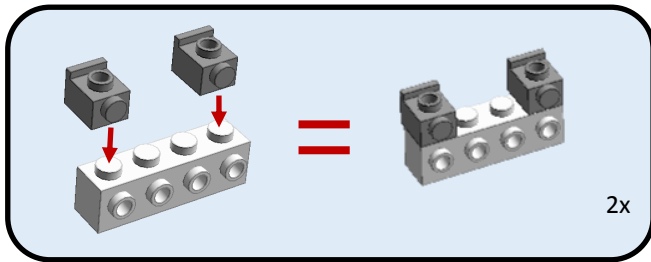

32

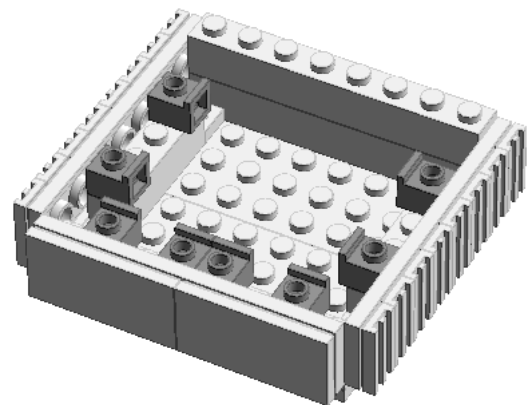
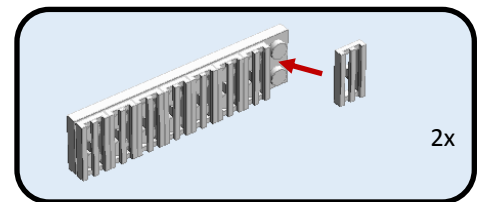

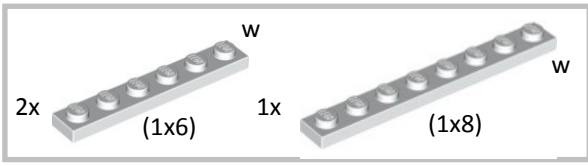

33

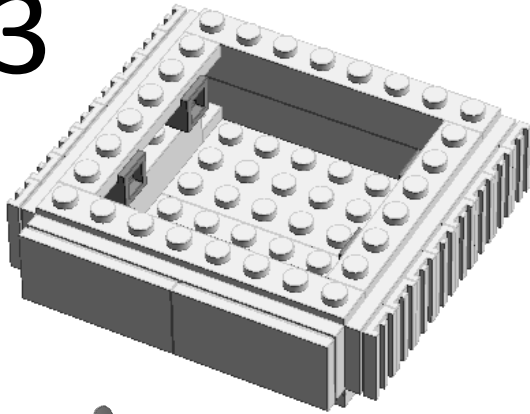

See animations showing the GPM instruments in action.

<http://go.nasa.gov/1dtqouJ>

<http://go.nasa.gov/1dtqyCt>

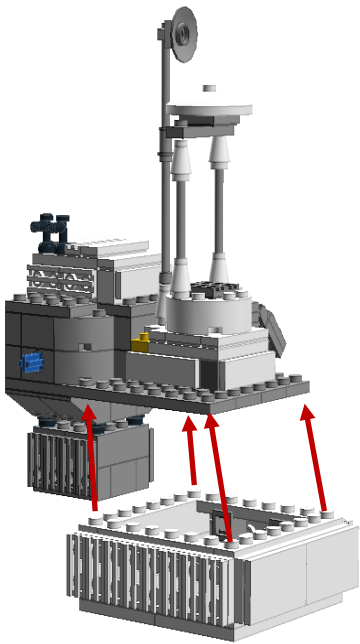

=

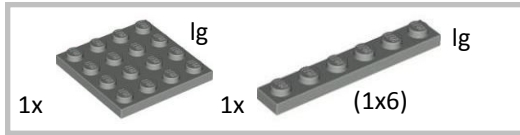
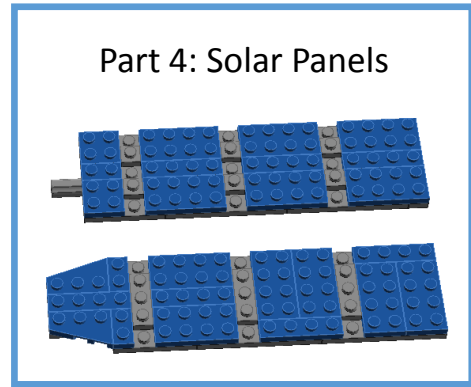
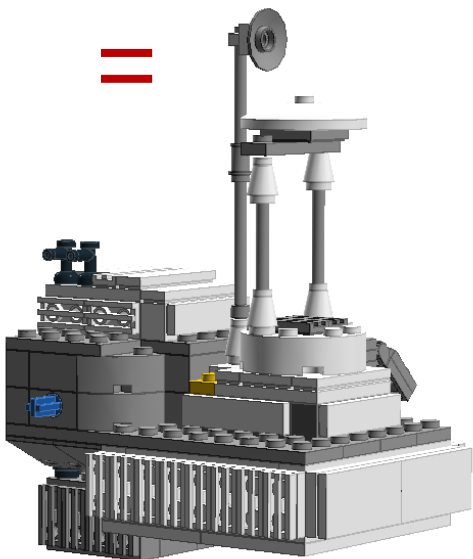

34

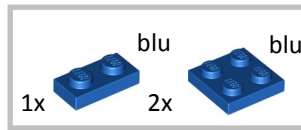
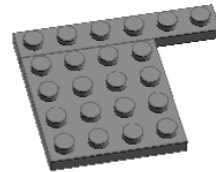

35

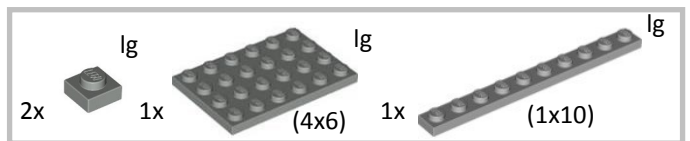
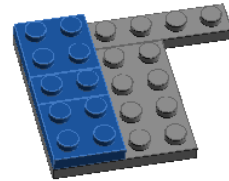

36

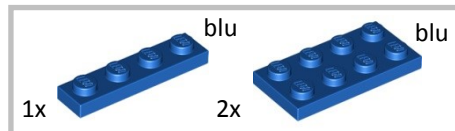
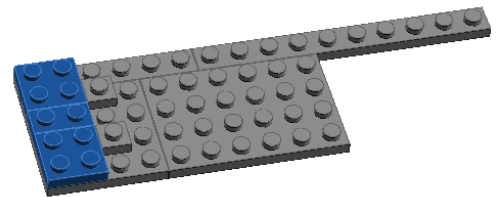

37

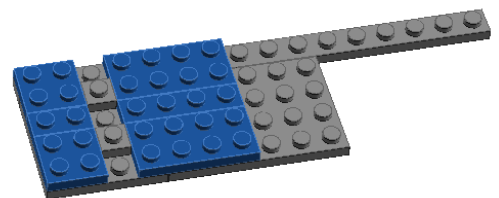

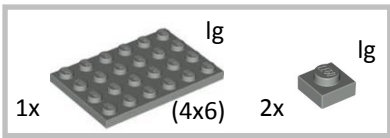

38

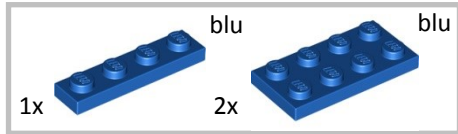
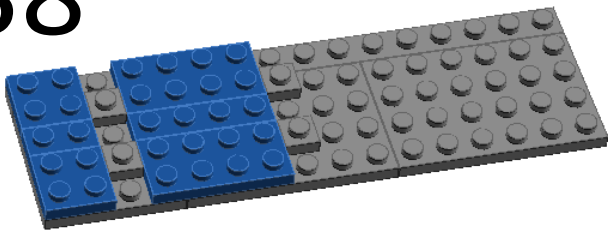

39

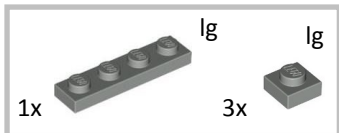
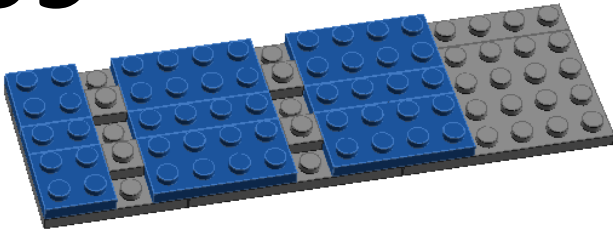

40

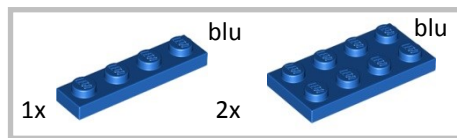
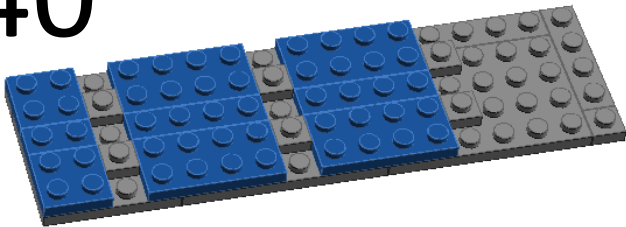

41

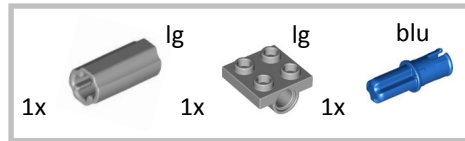
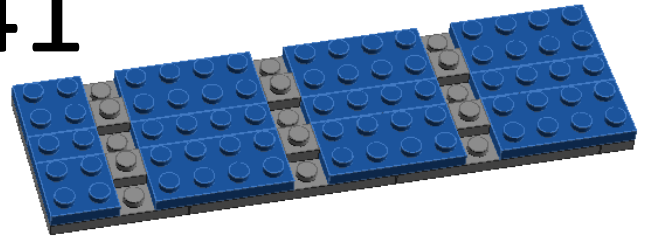

42

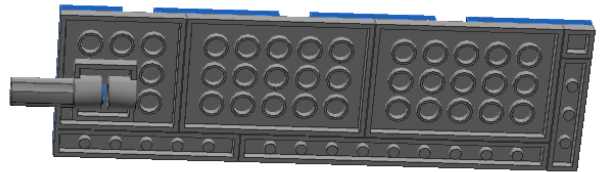
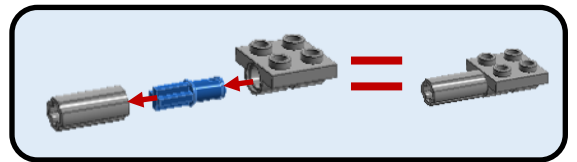

See a video showing a test deployment of the solar panels  
<http://go.nasa.gov/1dtq9zL>

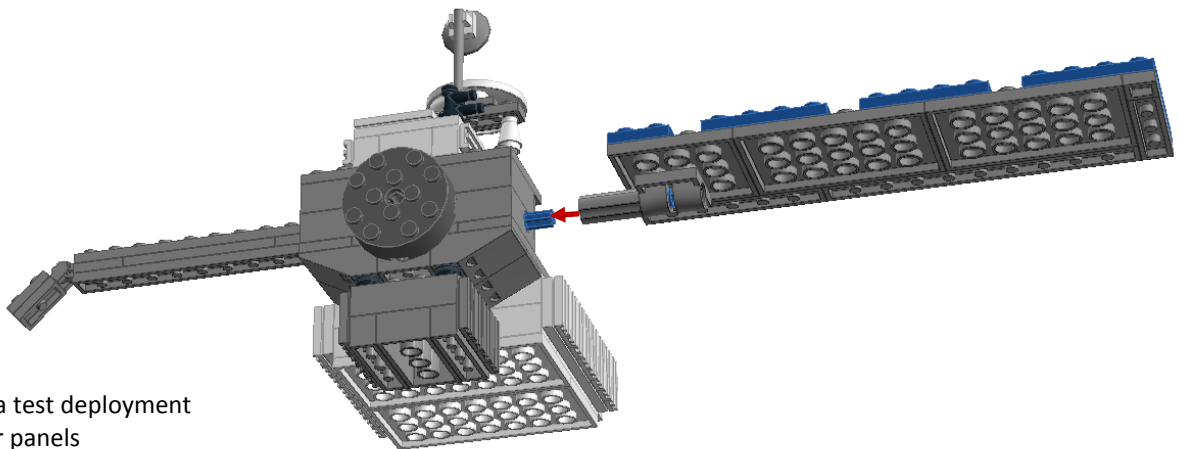

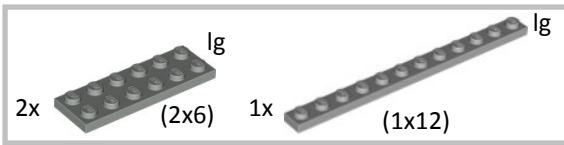

43

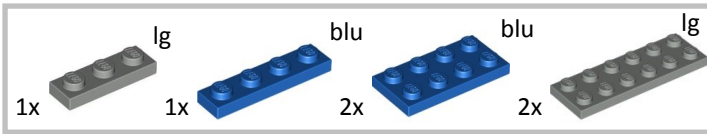
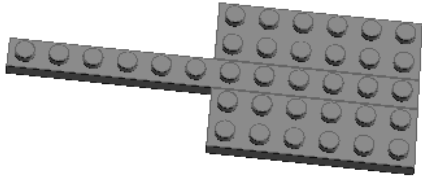

44

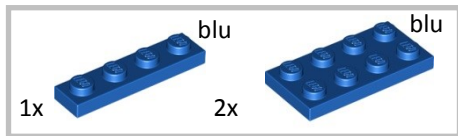
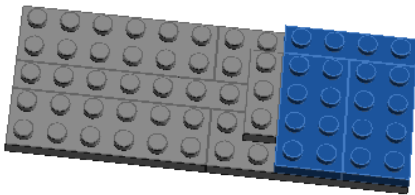

45

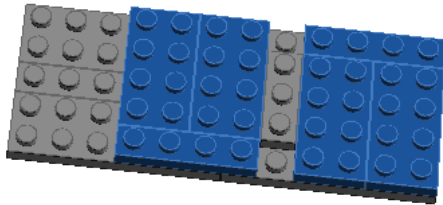

See an animated "beauty pass" of the satellite orbiting Earth.  
<http://go.nasa.gov/1r3cYru>

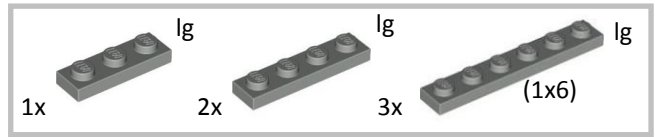

46

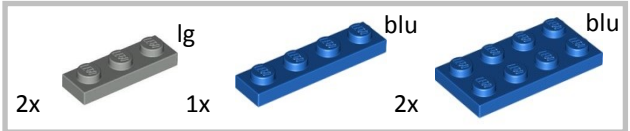
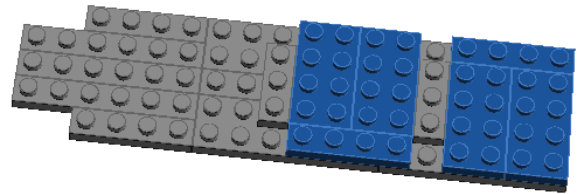

47

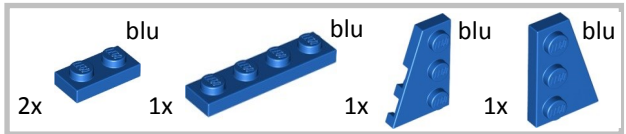
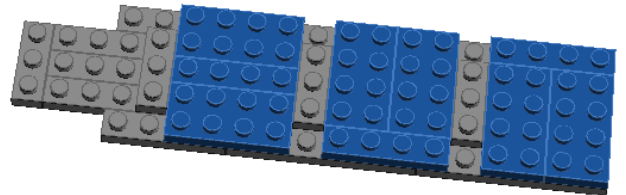

48

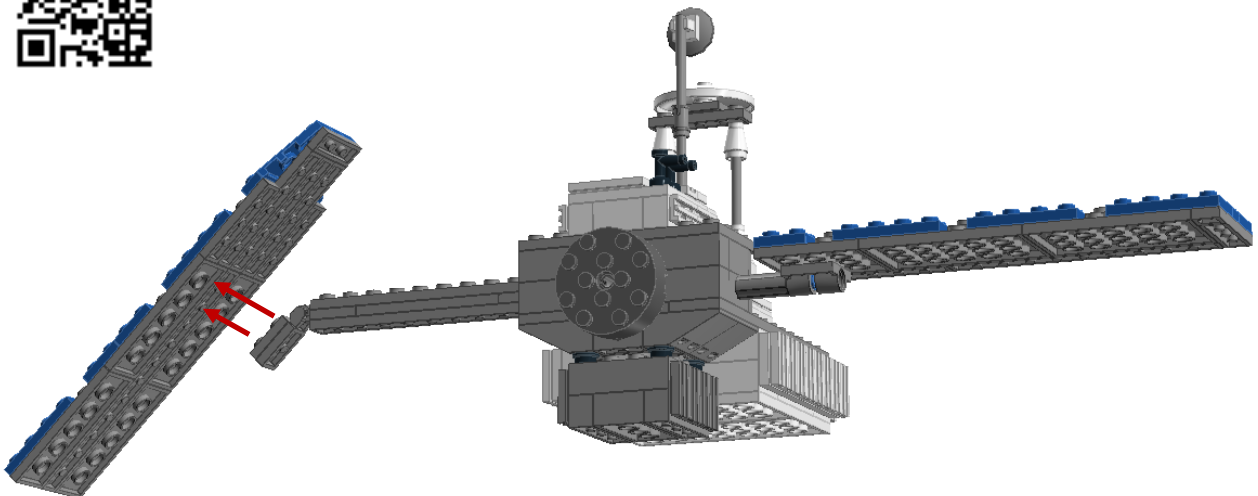
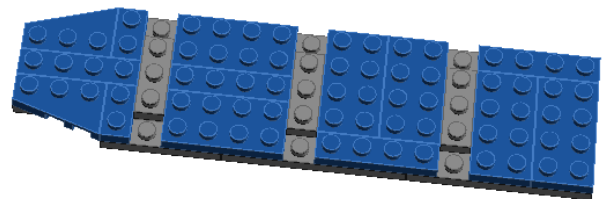

## Dual-Frequency Precipitation Radar (DPR)

The DPR provides three-dimensional information about precipitation particles in the different layers of clouds. It sends energy at two frequencies (Ku and Ka) into the cloud and observes the energy that is reflected back from different heights in the cloud. The DPR collects in-

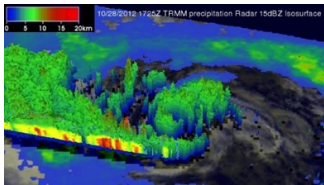
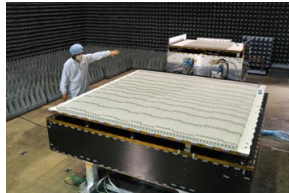

formation on the size, shape and distribution of raindrops, which improves rain estimates.

## GPM Microwave Imager (GMI)



The GMI is a radiometer instrument that measures microwave energy that is emitted naturally by precipitation within and beneath clouds. Different types of precipitation, like heavy rain and light snow, emit different wavelengths of energy. The GMI measures these wavelengths which scientists use to tell what kind and how much precipitation is in the cloud.

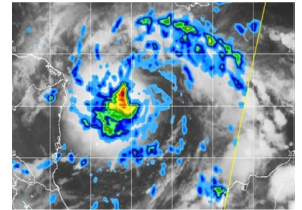

## High Gain Antenna



The High Gain Antenna allows the Core satellite to communicate with the ground and send real-time, continuous data from the GMI and DPR.

## Avionics / Star Trackers

Star trackers measure the position of stars and use a catalog of star locations to help the satellite know where it is in space.

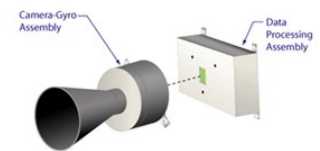

## Propulsion Module / Reaction Wheels

The propulsion system consists of the fuel and thrusters used to move the satellite while in orbit and the reaction wheels which maintain the Core Observatory's orientation. Together, they maintain and correct the orbit as needed throughout the life of the spacecraft. When the mission is over, they will drive the spacecraft into the atmosphere for a controlled re-entry to safely destroy it and send the pieces into the ocean.

## Solar Array



The GPM Core Observatory's two solar panels provide power for all the satellite's systems by converting sunlight into electrical energy.

## Math Connection:

- What scale is your completed model? The real solar panels on the GPM Core Observatory are 2.8 meters (9.2 feet) wide. Measure the panels on your model, and calculate how many times bigger the real thing would be.

## Engineering Challenge:

- After you build your model, come up with a creative way to display it. You might think of a museum exhibit and create a label and caption as well.
- The real satellite goes through a number of tests, including vibration testing, a vacuum chamber, and a ride on a centrifuge. Can you think of some ways to run similar tests on your model?

Light Gray



2x  
4211807



1x  
4512360



1x  
4211483



3x  
4211628



1x  
4538093



8x  
4211476



1x  
4211388



3x  
4211440



2x  
4211428



2x  
4211636



1x  
4211392

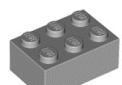

1x  
4211386



5x  
4211385



4x  
4211570



1x  
4211512



4x  
4567448



1x  
4211376



3x  
4565393



10x  
4211399



1x  
4211398



10x  
4211350



1x  
4211803



1x  
4211804



6x  
4211429



5x  
4211445



5x  
4211438



1x  
4251149



3x  
4514846



2x  
4211395



4x  
4211452



2x  
4211462



2x  
4211360



1x  
4243797

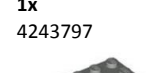

2x  
4211404



1x  
4211407

Dark Gray

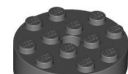

1x  
4558959



1x  
6030710



3x  
4210725

Black



2x  
459926



4x  
614126

Yellow



1x  
371024

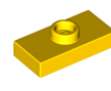

1x  
379424

White



5x  
4518400



4x  
302401

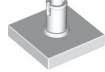

1x  
246001



1x  
396001



1x  
4558956



22x  
241201



2x  
306901



2x  
4558168

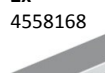

8x  
243101



2x  
366601



1x  
346001



1x  
300401



7x  
4143254



2x  
300801

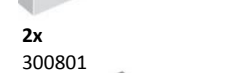

2x  
4560178



3x  
303401



2x  
4243812



2x  
303501

Blue

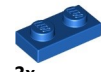

3x  
302323



2x  
4206482



7x  
371023



2x  
302223



12x  
302023



1x  
4498156



1x  
4498155

Note: LEGO brick numbers are subject to change. See our website for a spreadsheet of this parts list with more details about each piece if needed. <http://go.nasa.gov/Qrq3z>

